

User Manual

**FP Series UPS
1000VA-3200VA**



www.allis.com.tw

Contents

Safety information	I
Limited product warranty and policy	II
1. Presentation	1
1.1 General description	1
1.2 System configurations	2
1.2.1 Rack mount	2
1.2.2 Tower standalone	3
1.2.3 Single voltage battery design	4
• Battery Pack(BP)	4
• Battery Modules(BM)	4
• Battery Modules With Charger(BMc)	4
1.3 Front panel	5
1.4 Rear panel	6
• FP 1000/ FP1500/ FP 2200/ FP 3000 (UL)	6
• FP1000/ FP1600/ FP2500/ FP3200 (CE)	7
• Extended Battery Module	9
2. Installation	10
2.1 Unpacking	10
2.2 Installation in rack position	13
• Immovable	13
• Removable	14
2.3 Installation in tower position	15
2.4 LCD orientation	16
2.5 Connection to communications	17
2.5.1 Connection	17
2.5.2 Standard	18
• RS-232	18
2.5.3 Optional Interface Cards	19
2.5.3.1 DB9 Dry Contact Card	19
2.5.3.2 USB Card	20
2.5.3.3 AS400 Card	21
2.5.3.4 SNMP/HTTP Agent	22
• USHA Pro/ USHA ProE	22
• Net Agent II	23
3. Operation	24
3.1 Display and Controls	24
3.2 Starting up/shutting down the UPS	26
3.3 Operating Modes	27
3.4 Configuration Settings	29
• Green Mode	29
• Output Voltage	30
3.5 Cruiser Software	31
• Introduction	31
• Installation	32

Contents

4. Maintenance	36
4.1 General Maintenance	36
• Environment	36
• Storing the UPS and battery	36
• When to replace the battery.....	36
4.2 Battery Pack Replacement	37
4.3 Testing new batteries.....	38
4.4 Recycling the used battery	38
4.5 Fuse replacement	38
5. Troubleshooting	39
5.1 Audible alarms and status	39
5.2 Troubleshooting Guide	40
6. Appendix	41
6.1 Technical characteristics	41
• Design principle.....	41
• Components description	41
6.2 Specifications	43
• General specifications	43
• Battery Run Time	46
6.3 Contact information	47

Safety information

SAVE THESE INSTRUCTIONS. This UPS unit operates from utility power and contains a number of high current back-up batteries, the information is important to all personnel involved. **Please read this manual first before unpacking, installation and operation of the UPS.**

- ▶ **CAUTION: Safety of persons**
 - Opening or removing the cover of the unit may expose you to lethal voltage within the unit even it is apparently not operated and the input wiring is disconnected from electrical source.
 - Refer all UPS and battery service to authorized service personnel from the manufacture or agent authorized by the manufacturer.
 - Do not dispose battery in a fire. The battery may explode.
 - Do not open or mutilate the battery. Release electrolyte is harmful to skin and eyes. It may be toxic.
 - The following precautions should be observed when working on batteries:
 - Remove watches, rings, and other metal objects.
 - Use tools with insulated handles.

- ▶ **CAUTION: Product Safety**
 - Install the UPS in a clean environment, free from moisture, flammable gases or fumes and corrective substances.
 - Keep the UPS on a flat, stable surface with adequate space around it for proper ventilation.
 - Operate the UPS in an indoor environment only in an ambient temperature range of **32°F to +104°F (0°C to +40°C)**.
 - The UPS is designed for data processing equipment. It is not intended for use with life support and other designated "critical" devices.
 - Maximum load must not exceed that shown on the UPS rating label.
 - Storing magnetic media on top of the UPS may result in data loss or corruption.
 - Once batteries have reached the end of their life, ensure they are disposed properly. REFER TO YOUR LOCAL LAWS AND REGULATIONS FOR BATTERY DISPOSAL REQUIREMENTS.
 - The UPS must be handled with care and attention since the high energy stored within the batteries. It must always be kept in the position marked on the external packaging and must not be dropped.
 - Please keep unobstructed air in the exhaust holes of UPS.
 - The battery should be maintained on a regular time schedule.

- ▶ **CAUTION: Special Precautions**
 - The UPS should be installed according to the instructions in this manual. Failure to do so could result in safety issues. It could also invalidate your warranty.
 - DO NOT CONNECT equipment that could overload the UPS or demand half-wave rectification from the UPS, for example: **electric drills, vacuum cleaners, printers or hair dryers.**
 - Adjust only those controls that are listed by the Adjustment Section. If the unit does not operate normally by following the operating instructions, contact the sales representatives.

Icon Usage

These icons may be found in the content.



WARNING: Obvious danger to personnel or equipment.



CAUTION: Possible danger to personnel or equipment



Important information

Limited product warranty and policy

- **Limited Product Warranty-**

AEC warrants this equipment, when properly applied and operated within specified conditions, against faulty materials or workmanship for a period of 24 months after the date of purchase. For equipment located outside Taiwan, AEC only covers faulty parts. AEC products repaired or replaced pursuant to this warranty shall be warranted for the unexpired portion of the warranty applying to the original product. This warranty applies only to the original purchaser.

This warranty does not cover shipping costs, installation costs, maintenance and service items, calibration and adjustment. Repair or replacement of a defective part, or the crediting to the user of the value thereof, does not extend the original warranty period.

- **Warranty policy-**

The warranty shall be void if (a) the equipment is damaged by the customer, is improperly used, is subjected to an adverse operating environment, or is operated outside the limits of its electrical specifications; (b) the equipment is repaired or modified by anyone other than AEC or AEC-approved personnel; or (c) has been used in a manner contrary to the product's operating manual or other written instructions. All claims under this warranty must be submitted in writing to AEC within 30 days of the occurrence or the claim will not be considered. This warranty does not include damage resulting from accident or misuse.

AEC reserves the right to determine whether the damage to the connected equipment is due to malfunction of the AEC product by requesting the equipment in question to be sent to AEC for examination. This policy is above and beyond, only to the extent needed, of that provided by any coverage of connected equipment provided by other sources, including, but not limited to, any manufacturer's warranty and/or any extended warranties.

EXCEPT AS PROVIDED ABOVE, AEC MAKES NO WARRANTIES, EXPRESS OR IMPLIED, INCLUDING WARRANTIES OF MERCHANTABILITY AND FITNESS FOR A PARTICULAR PURPOSE.

EXCEPT AS PROVIDED ABOVE, IN NO EVENT WILL AEC BE LIABLE FOR DIRECT, INDIRECT, SPECIAL, INCIDENTAL OR CONSEQUENTIAL DAMAGES ARISING OUT OF THE USE OF THIS PRODUCT, EVEN IF ADVISED OF THE POSSIBILITY OF SUCH DAMAGE. Specifically, AEC is not liable for any costs, such as lost profits or revenue, loss of equipment, loss of use of equipment, loss of software, loss of data, costs of substitutes, claims by third parties or otherwise. Coverage also does not apply to connected medical and industrial equipment.

To receive service under this warranty, you must be the original purchaser/user of the product in question. You must obtain a Returned Material Authorization (RMA) number from AEC. Products must be returned to AEC with transportation charges prepaid and must be accompanied by a brief description of the problem encountered and proof of date and place of purchase.

The policy of AEC is one of continuous improvement. Specifications are subject to change without notice.

1. Presentation

1.1 General description

In today's world where power requirements are increasing, utility power quality and reliability is decreasing. Normal everyday routines are constantly exposed to power problems such as power outages, sags, or surges. Any of these problems can spell disaster for the unprepared. Down time resulting from power problems costs industries billions of dollars over the course of a year. Industrial and commercial end-users need to be prepared when the power that they rely on is also a potential problem.

One way to protect critical systems from power outage and sags is the FP-series line of true on-line uninterruptible power supplies (UPS). The FP-series UPS is designed for optimizing power quality with the ease of installation.

The FP series Features:

- Double conversion
- Continuous battery charger and inverter for primary power path
- Constant battery connection to inverter and load
- Guaranteed full power operation during power failure
- No voltage drop and zero transfer time
- Light weight unit
- Hot-swappable battery
- User-friendly Graphic LCD

Applications :

- Computers
- Network Servers
- Workstations
- Wireless Communications
- Other Electronic Peripherals

1. Presentation

1.2 System configurations

1.2.1 Rack mount

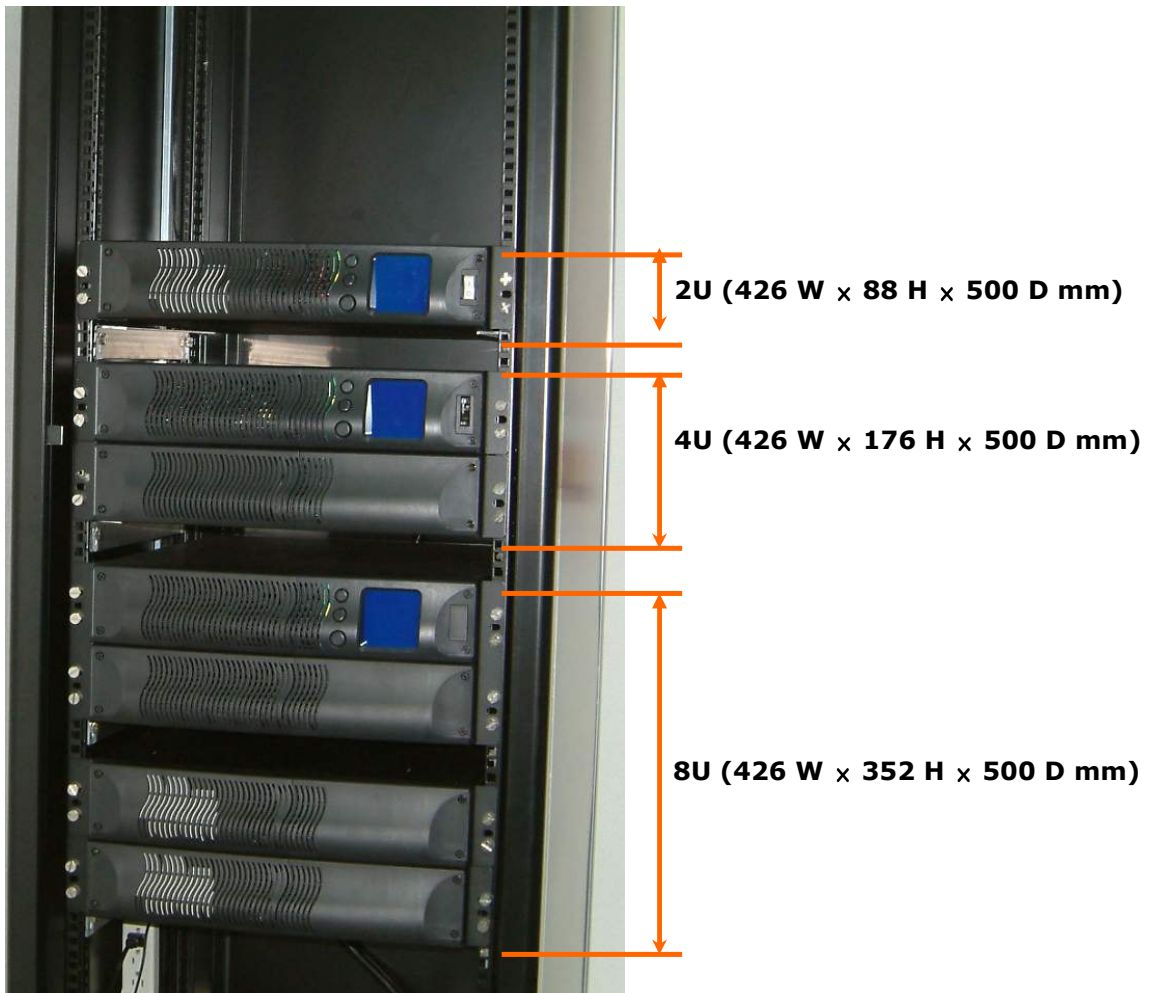

1. Presentation

1.2.2 Tower standalone

2U (88 Wx 426 H x 500 D mm)



4U (176 Wx 426 H x 500 D mm)

6U (264 Wx 426 H x 500 D mm)



1. Presentation

1.2.3 Single voltage battery design

▶ **Battery Pack(BP)**



The 48VDC standard battery pack contains four 4 × 12V7AH lead-sealed acid batteries. It is used in all FP series UPS models and is interchangeable with each other.

▶ **Battery Modules(BM)**



The battery module contains two(2) Battery Packs. The standard 2U high single module design always for easy configuration when adding extra battery modules for extended backup times.



▶ **Battery Modules With Charger(BMc)**



The BMc is a BM with an added battery charger. The charger shortens the recharge time of the batteries.



Additional battery charger

1. Presentation

1.3 Front panel

▶ FP1000/FP1500/FP1600

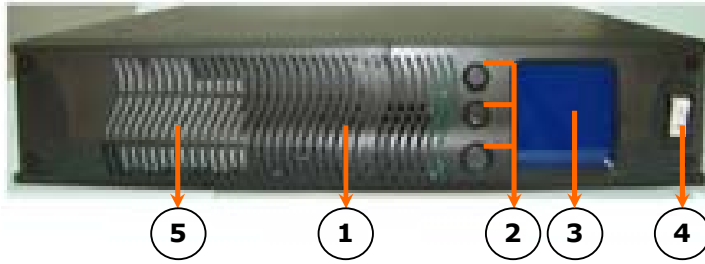

1. Vent
2. Push Buttons
3. Graphic LCD Display
4. Input Breaker Switch
 - FP1000: 15A 125V (UL) or 10A 250V (CE)
 - FP1500: 15A 125V (UL)
 - FP1600: 10A 250V (CE)
5. Internal 48VDC Battery Pack

▶ FP2200/FP2500/FP3200

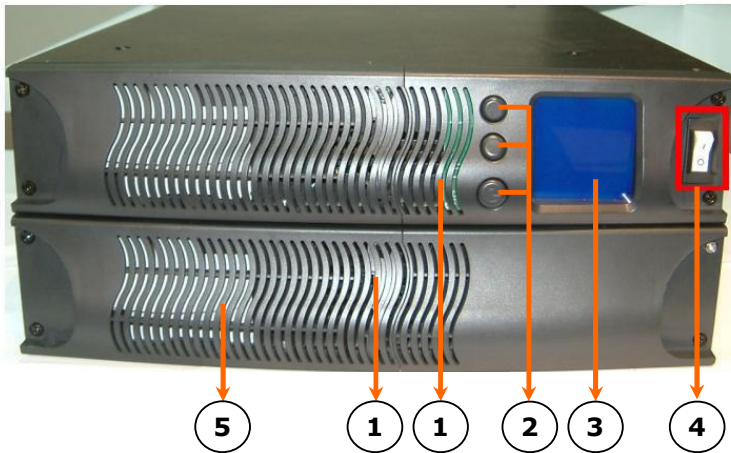

1. Vent
2. Push Buttons
3. Graphic LCD Display
4. Input Breaker Switch
 - FP2200: 20A 125V (UL)
 - FP2500: 15A 250V (CE)
 - FP3200: 20A 250V (CE)
5. 2U 96VDC Battery Module

▶ FP3000

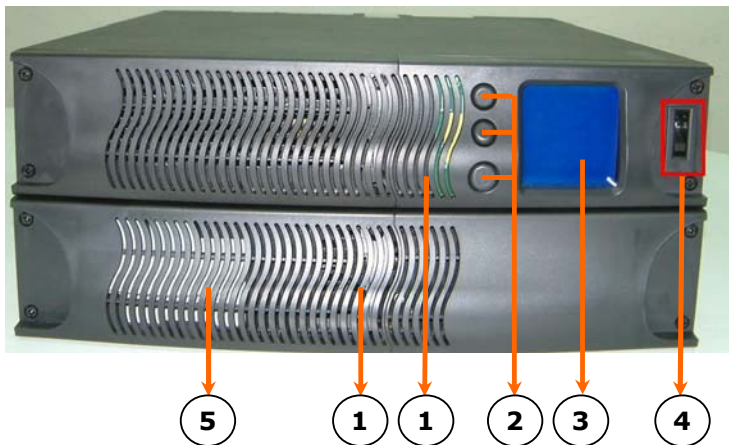

1. Vent
2. Push Buttons
3. Graphic LCD Display
4. Input Breaker Switch
 - FP3000: 30A 125V (UL)
5. 2U 96VDC Battery Module

1. Presentation

1.4 Rear panel

FP 1000/ FP1500/ FP 2200/ FP 3000 (UL)

▶ FP1000/FP1500

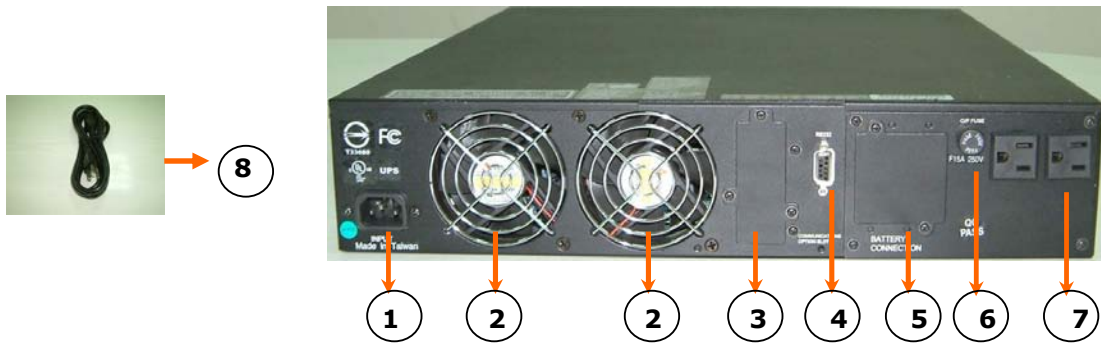

- 1. Input Receptacle (15A 125V)
- 2. Fan
- 3. Optional Communication Slot
- 4. Standard RS232
- 5. Battery Connector
- 6. Output Fuse (15A 250V)
- 7. Output Receptacle (NEMA 5-15R)
- 8. Input cable 6' (10A 250V)

▶ FP2200

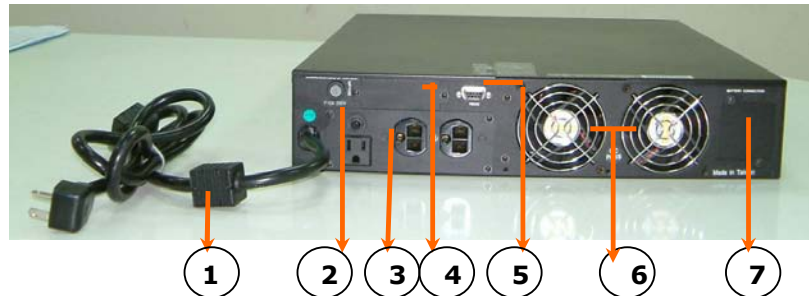

- 1. Power Cord 6' (NEMA 5-20P; 20A 125V)
- 2. Output Fuse (15A 250V)
- 3. Output Receptacles (NEMA (1)5-15R; (2)5-20R)
- 4. Optional Communications Slot
- 5. Standard RS232
- 6. Fan
- 7. Battery Connector

1. Presentation

► **FP3000**

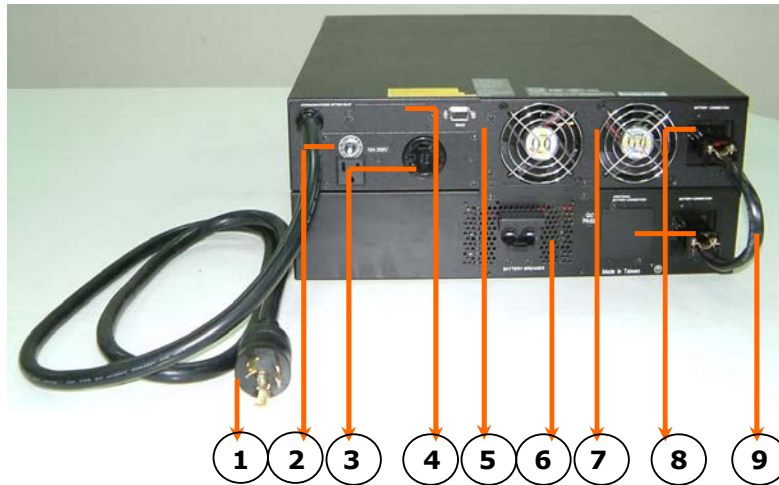

- | | |
|--|----------------------------|
| 1. Power Cord 6' (NEMA L5-30P; 30A 125V) | 6. Battery Circuit Breaker |
| 2. Output Fuse (15A 250V) | 7. Fan |
| 3. Output Receptacles (NEMA (1)5-15R; (1)L5-30R) | 8. Battery Connector |
| 4. Optional Communications Slot | 9. Battery Cable |
| 5. Standard RS232 | |

FP1000/ FP1600/ FP2500/ FP3200 (CE)

► **FP1000/ FP1600**

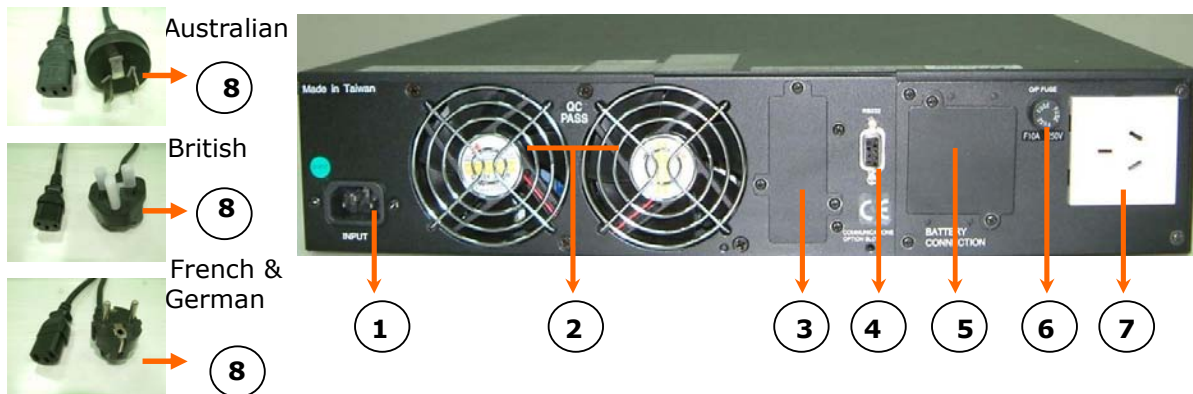

- | | |
|---------------------------------|--|
| 1. Input Receptacle (10A 250V) | 5. Battery Connector |
| 2. Fan | 6. Output Fuse (10A 250V) |
| 3. Optional Communications Slot | 7. Output Receptacle (refer to ) |
| 4. Standard RS232 | 8. Input cable 6' (10A 250V) |

1. Presentation



Output Receptacle options for FP1000/ FP1600.

1. IEC TYPE

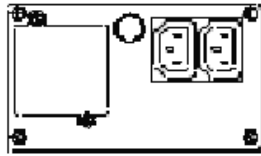

2. EUROPE TYPE

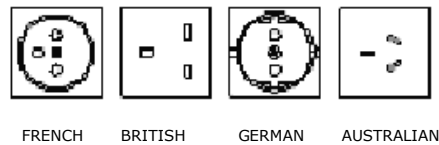
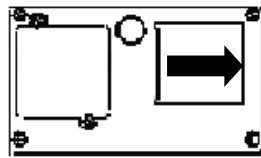

FRENCH BRITISH GERMAN AUSTRALIAN

▶ FP2500/ FP3200

Australian



10



British

10



French & German

10

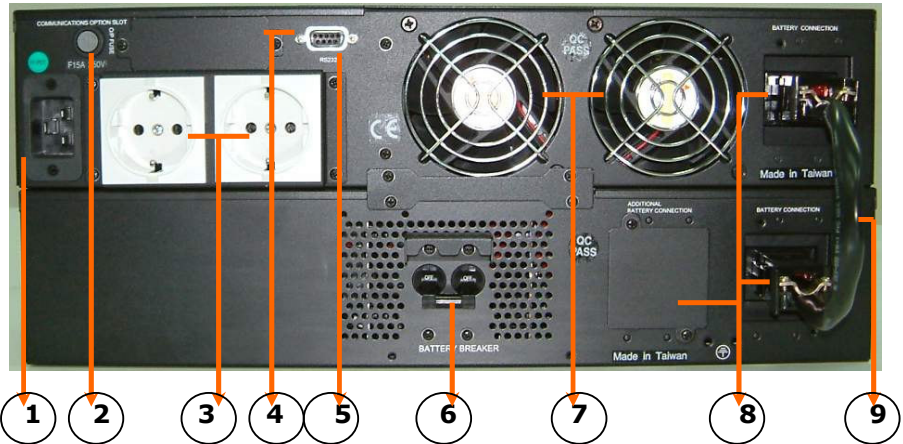

- 1. Input Receptacle (15A 250V)
- 2. Output Fuse (15A 250A)
- 3. Output Receptacles (refer to)
- 4. Optional Communication Slot
- 5. Standard RS232

- 6. Battery Circuit Breaker
- 7. Fan
- 8. Battery Connector
- 9. Battery Cable
- 10. Input Cable 6' (16A 250V)



Output receptacle options for FP2500/ FP 3200.

1. IEC TYPE

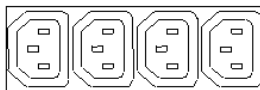

2. EUROPE TYPE

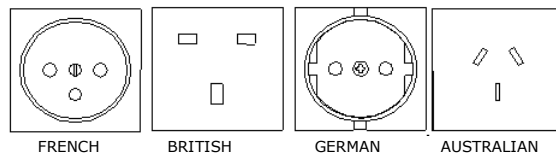

FRENCH BRITISH GERMAN AUSTRALIAN

1. Presentation

Extended Battery Module

- ▶ **How to plug in the battery connector ?**



Before plugging in battery connector, please make sure the UPS unit is off. This is a critical action to ensure the safety of the installer.

- ▶ **How to add on the additional BM or BMc ?**

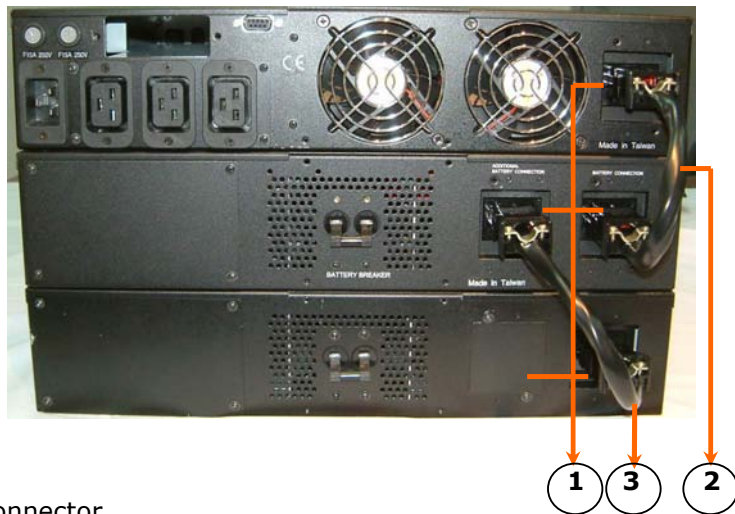

1. Battery Connector
2. Standard Battery Cable
3. Additional Battery Cable

2. Installation

2.1 Unpacking

The FP-Series UPS can be supplied in a number of boxes depending upon the model ordered. The number of boxes should be as follows:

MODEL (Box 1)	BATTERY MODULE (Box 2)	TOTAL BOXES
FP1000/FP1500/FP1600	N/A (internal battery pack)	1 Box
FP2200/FP2500/FP3000/FP3200	1 Battery Module	2 Boxes



The UPS and its shipping box are both labeled with the same bar code and serial number. If the UPS has a problem, then please have the information on the label ready and contact your sales representative.



2. Installation

▶ FP1000/FP1500/FP1600

Shipping Box



1



2



3

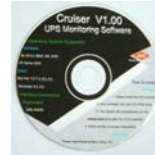

4 user manual



5



Mounting- feet x 2

6



Rack-mount x 2

7



Shipping Box Includes:

1. UPS
2. RS-232 communications cable
3. Cruiser software installation CD
4. User Manual (CD)
5. 2pcs mounting-feet for tower configuration
6. 2pcs 19" rack ears (+screws) for rack-mount configuration
7. Power Cord (for FP1000/FP1500/FP1600 only)

2. Installation

▶ FP 2200/FP2500/FP3000/FP3200

Box 1



(Please refer to Shipping Box contents included in FP1000/FP1500/FP1600 previous page)

Box 2



1



2



3

4

5



Box 2 Includes:

1. BM (or BMc)
2. 2pcs Extension link for tower configuration
3. 2pcs 19" rack ears (+screws) for rack-mount configuration
4. A steel link to connect the UPS and BM (or BMc)
5. Battery cable

2. Installation

2.2 Installation in rack position

▶ Immovable



The rack-mount ears WILL NOT support the weight of the UPS nor the battery module. They are used for mounting the UPS and battery module onto the rack. Mounting rails are required for each UPS or battery module. If rails are not installed on the rack, then please contact your service representative to order a rail kit.

1. Align the mounting ears and secure with the supplied screws.

2. Slide the UPS or battery module onto the fixed mounting rails.

3. Secure the mounting ears to the posts.

4. Repeat the above steps for each UPS and battery module until installation is complete.

2. Installation

▶ **Removable**

Optional slide rails are available. Please contact your sales representative for more details.



1. Align the mounting ears and secure with the supplied screws.



2. Fasten the inner parts of the slide rails to the UPS or battery module with the screws provided.



3. Secure slide rails to posts. As a precaution , fixed mounting rails should be installation below the slide rails.



4. Slide the UPS or battery module into the slide rails.



5. Repeat the above steps for each UPS and battery module until installation is complete.

2. Installation

2.3 Installation in tower position

The mounting feet feature as flexibility in configuration and are able to add on the other Battery module using extendible links to meet long runtimes requirement.

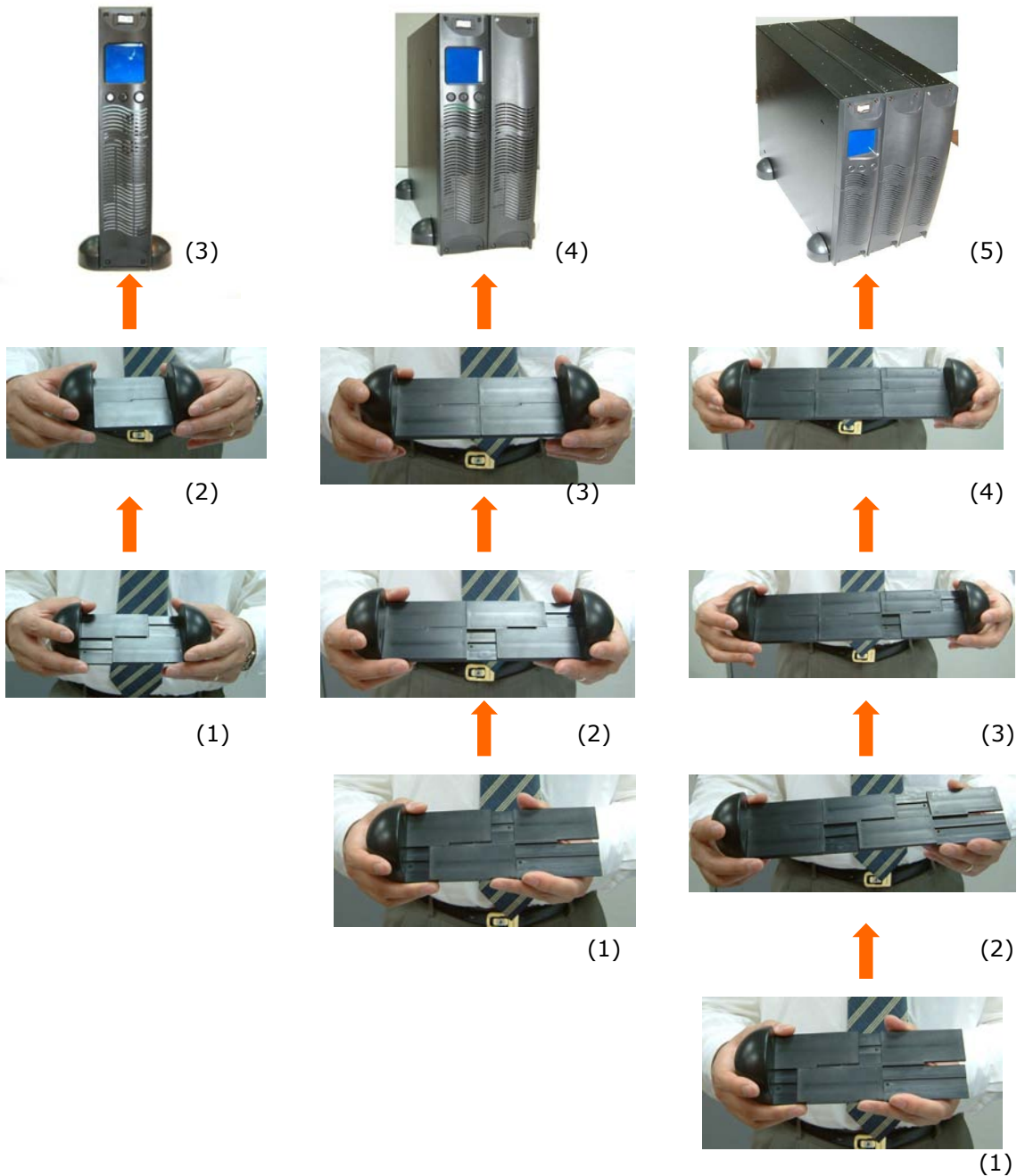

2. Installation

2.4 LCD orientation

The graphic LCD display has been designed so that it can be easily oriented for tower or rack-mount configuration.



Make sure that the UPS is shutdown before beginning. Ensure that the input breaker switch is in the OFF position.

1. Remove the top cover.



2. Detach the cables from the input breaker.



3. Remove the front panels.

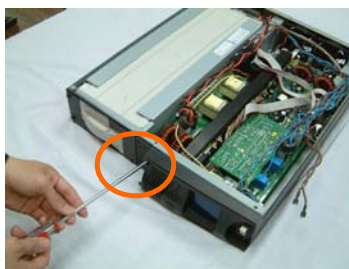
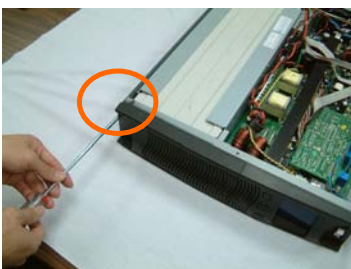

4. Remove the screws from the display board and rotate the display board clockwise 90 degree for rack-to-tower configuration or counter-clockwise 90 degree for tower- to-rack configuration.



2. Installation

2.5 Connection to communications

2.5.1 Connection

- ▶ **Standard RS-232 Connection**



- ▶ **Optional USB Card Connection**



2. Installation

2.5.2 Standard

▶ **RS-232**

The UPS unit is supplied with a RS-232 cable to connect a local computer or modem to a remote computer installed with the "Cruiser" software. It can be used to monitor or control the UPS locally or remotely. Please refer to the chapter 3.5 Cruiser software or the Cruiser installation disk for details.

The pins of the connector are as following:

PIN #	PIN Definition (UPS)	PIN Definition (PC)
2	Transmitted data	Received data
3	Received data	Transmitted data
4	DTE Ready	DTE Ready
5	Signal Ground	Signal Ground

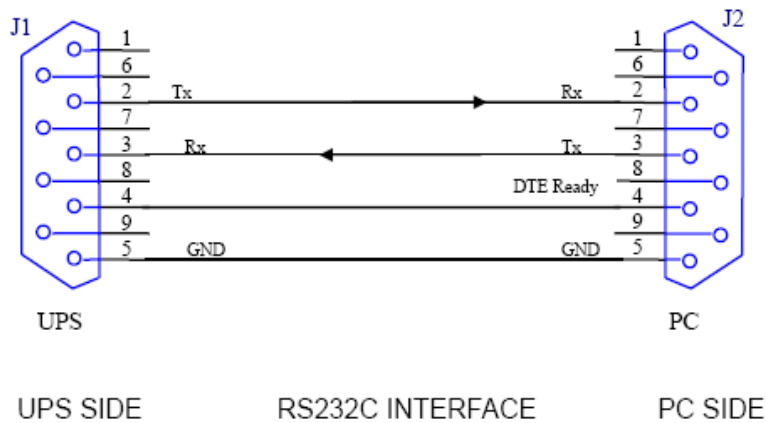

The RS-232 interface setting are as follows:

Baud Rate	2400 bps
Data Length	8 bits
Stop Bit	1 bit
Parity	None

2. Installation

2.5.3 Optional Interface Cards



The spare communication slot can be used with optional interface cards such as DB9 Dry Contact Card, USB Card, AS400 Card, and SNMP/HTTP Card.

2.5.3.1 DB9 Dry Contact Card

► **For Novell**



The DB9 Dry Contact Card offers three relay outputs for custom-wired application. The figure below shows the interface for the system connection:

Pin Definition of DB9 for NOVELL Interface

PIN # of DB9	Function explanation	I/O
2	POWER FAILURE - normally open state, will become closed during active state.	OUTPUT
3	POWER FAILURE - normally closed state, will become open during active state.	OUTPUT
4	Reference GND for pin 2,3 and 5.	OUTPUT
5	BATTERY LOW - normally open state, will become closed during active state.	OUTPUT
6	Remote shut-down UPS - keep this pin at high voltage (+5V~+12V), needs 500 ms to shut down UPS. Activates at battery mode.	INPUT
8	FAULT - normally open state, will become closed during UPS fault.	OUTPUT

2. Installation

▶ **For Mechanical Dry Contact**



The DB9 Dry Contact Card offers three relay outputs for custom-wired application. The figure below shows the interface for the system connection:

PIN Definition of DB9 for Mechanical Dry Contact interface

PIN # of DB9	Function explanation	I/O
1,2	BATTERY LOW - normally closed state, will become open during active state. (PIN 2 is common)	OUTPUT
3,5	POWER FAILURE - normally open state, will become closed during active state. (PIN 5 is common)	OUTPUT
4,5	POWER FAILURE - normally closed state, will become open during active state. (PIN 5 is common)	OUTPUT
6,7	Remote shut-down UPS - keep this pin at high voltage (+5V~+12V), needs 500 ms to shut down UPS. Activates at battery mode.	INPUT
8,9	FAULT - normally close state, will become open during UPS fault. (PIN 9 is common)	OUTPUT

2.5.3.2 USB Card

When the connected computer only has USB ports, an optional USB 1.0 can be used in the communication slot. A USB cable is supplied with the card.



2. Installation

2.5.3.3 AS400 Card

FP-Series provide slot for AS/400 card. The AS/400 Integration of Lotus Notes is a blending of the administration, management, and security of the most popular business application system, the AS/400, with the world's leading messaging and groupware product, Lotus Notes.

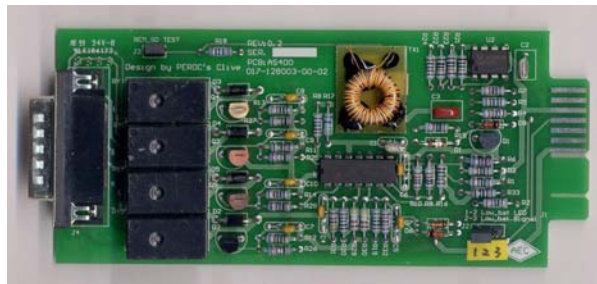

For more details about AS/400, please visit IBM'S website "www.ibm.com"

2. Installation

2.5.3.4 SNMP/HTTP Agent

▶ **USHA Pro**



USHA ProE



USHA (UPS SNMP and HTTP Agent) – USHA allows a user to obtain the status of and issue commands to the UPS. The UPS can be managed through the use of SNMP managers or Web browsers. USHA also provides shutdown programs for different operating systems. Shutdown commands can be sent for such events as power failure, low UPS battery condition, UPS overload, UPS overheating and scheduled shutdowns. All shutdown events are configurable by the user. The shutdown software follows an automatic orderly shutdown to prevent the abnormal shut-off of clients or servers.

The internal card version (USHA Pro) is designed for UPS models, which have the extension board slot where USHA can be inserted and connected to the UPS through the golden fingers as in Figure 1-1. The external box version (USHA ProE) is designed for UPS models that are not equipped with the extension board slot; connection between USHA and the RS-232 communication port of UPS is through a serial cable as shown in Figure 1-2.



Figure 1-1: USHA Pro



Figure 1-2: USHA ProE



For more details about USAH Pro, please refer to the USHA Pro installation CD.

2. Installation

▶ **Net Agent II**



(External)



(Internal)

NetAgent II allows a user to obtain the status of and issue commands to the UPS. It also provides other functions such as connecting to a modem to monitor the UPS when a permanent connection to the internet is not available. Monitoring the status of such things as temperature, humidity, water conditions, smoke detectors, gas detectors, and door and window detectors is also possible with NetAgent II when it is connected to optional components. This product is for "Contact Closure" and "RS232" interface UPS. The communications protocol includes the MegaTec/ PPC/ SEC 2400 / 9600. And user could also provide their own protocol to build in. NetAgent II provides a simple and easy installation procedure. User only needs to install the software in the NetAgent II CD on a Windows environment to configure the IP address. All the other configurations could be accomplished in a Web browser. NetAgent II also provides shutdown programs for different operating systems. Shutdown commands can be sent for such events as power failure, low UPS battery condition, UPS overload, UPS overheating and scheduled shutdowns. All shutdown events are configurable by the user. The shutdown software provides an orderly shutdown to prevent the abnormal shut-off of clients or servers.



For more details about NetAgent II, please refer to the NetAgent II installation CD.







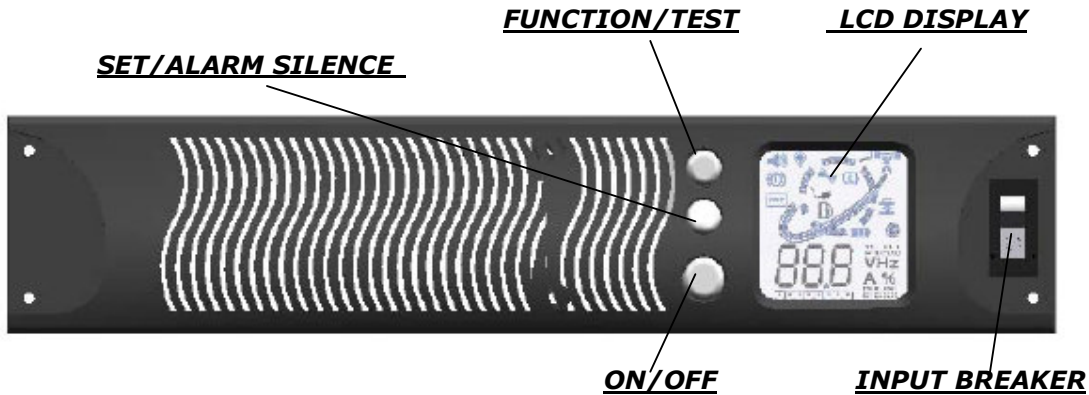







3. Operation

3.1 Display and Controls

The diagram below show the basic functions of the front panel on all FP series UPS.



► SYMBOLS USED ON GRAPHIC LCD DISPLAY

-  **Alarm:** When the UPS fails, the symbol will flash.
-  **Green Mode:** When UPS is in Green Mode, the symbol will flash.
-  **Fault:** When the UPS has failed and must be repaired, the symbol will flash.
-  **Test:** When UPS is conducting Battery Self-Test under Normal Mode, the symbol will flash.
-  **Load:** The higher the load, the more bars will illuminate.
-  **Inverter:** When Inverter is normal, the symbol will illuminate.
-  **Power Factor Corrector (PFC):** When PFC is normal, the symbol will illuminate.
-  **Input Power:** When utility power is normal, the symbol will illuminate.
-  **Charger:** When charger is in normal operation, the symbol will illuminate.
-  **Booster:** When UPS starts Battery Booster, the symbol will illuminate.
-  **Battery:** The bars indicate an approximate amount of battery charge remaining. Each bar represents 25% of battery capacity.
-  **High-speed Fan:** UPS is in Battery Mode.
-  **Medium-speed Fan:** UPS is in Normal Mode.
-  **Low-speed Fan:** UPS is in Bypass Mode.

3. Operation

▶ **CONTROLS**

→ **INPUT BREAKER SWITCH**

- This switch disconnects the input power to the UPS.

→ **FUNCTION/TEST BUTTON**

This button has two functions:

1. Manual Battery Test

- When the UPS is working under normal conditions, press this button to self-test the battery for 10 seconds. During this test, the battery will supply the UPS with power. If the battery are supplying unstable voltages, then the audible alarm will produce one long beep and the UPS will switch to receiving power from the utility source.

2. Configuration UPS Settings

- When pressed together with the SET/ALARM SILENCE button for three seconds, allows the user to configure UPS settings.

→ **SET/ALARM SILENCE BUTTON.**

This button has three functions

1. Silence Alarms

- Press this button for one second and the alarms will be silenced. After the alarm is silenced, the UPS cannot audibly alert users of any additional problems.



Overheating, PFC Over-current, Inverter over-current, Overload, Battery mode, Low battery in battery mode, and charger failure alarms cannot be silenced.

2. Change Selection

- Pressing the button for second will allow the user to view various parameters and measurements including Input Voltage, Output Voltage, Output Frequency, Battery Voltage, percent of Load, percent of Input current, Internal Temperature of the unit, and Output Current.

3. Configuration Settings

- When pressed together with the FUNCTION/TEST button for three seconds, allows the user to configure UPS settings.

→ **ON/OFF BUTTON.**

This button controls output power to the load and has two functions:

1. Force UPS into Bypass Mode.
2. Start UPS from battery when utility power in not available.



When the UPS is in Normal Mode operation, pressing the ON/OFF button once will put UPS into Bypass Mode. Pressing this button again will force the UPS back to Normal Mode. If utility power is not available and UPS is not connect with higher than 3% load, then the UPS will shut down after 30-40 seconds.

3. Operation

3.2 Starting up/shutting down the UPS

▶ **Normal Start-up of the UPS**

Step 1. Plug the UPS into an AC power source.

Step 2. Turn on the Input Breaker switch. The UPS will begin its start-up process by first going into Bypass Mode and then into Normal Mode. After entering the Normal Mode, the UPS is ready for operation.

▶ **Shutting down the UPS**

Step 1. Press ON/OFF key for one second. The UPS will switch to Bypass Mode.

Step 2. Turn off the Input Breaker switch. Display will turn off.



During shutdown, do not press any buttons. Pressing a button may cause the UPS to re-energize and deliver output power.

▶ **Battery Start-up of the UPS**

To turn on the UPS without using utility power, press the ON/OFF button. The UPS will begin supplying power through its batteries.

3. Operation

3.3 Operating Modes

▶ **NORMAL MODE**

During normal operation, utility power provides energy to the UPS. The UPS converts the utility power to computer-grade power for the connected loads. The UPS will also maintain the batteries at a fully charged state.

All indicators are stable except Alarm. The graphic LCD display shows indicators of load, Inverter, PFC, Input power, Charger, Battery, Fan in medium speed, Green Mode, Fault, and Test. A solid line shows the power flow from input to the load and batteries. The display will also show the status of the measuring parameters by pressing the SET/ALARM SILENCE button.

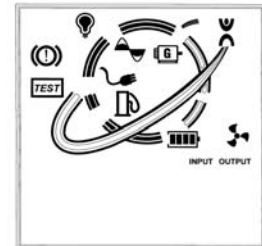

▶ **BATTERY MODE**

Battery Mode occurs in the event of a utility power failure or an extreme input voltage condition. The batteries will supply power to the connected load through the DC/DC converter and the DC/AC inverter. When utility power is restored, the UPS switches to Normal Mode operation and recharges the batteries. While in Battery Mode, an alarm will beep. The beeping frequency will continue to increase as an indication that the batteries are running low and that the UPS is about to shut down. If the UPS shuts down, then it will automatically restart when utility power is restored.

In Battery Mode, a solid line will be lit from the Battery symbol to Booster and Inverter symbols. The High-speed Fan symbol will also be lit. The battery bars will indicate the remaining battery capacity. As capacity decreases, the number of bars will also decrease.

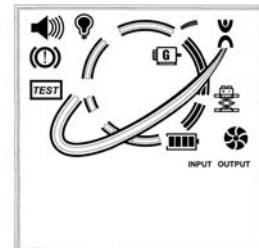

For approximate battery run times, please refer to the Battery Run Time chart at the end of this manual. The run time is based on resistive load and an ambient temperature of 77°F (25°C). To increase the run time, turn off non-essential equipment or add an optional external battery module.

3. Operation

▶ **BYPASS MODE**

In the event of a UPS overload or internal failure, an audible alarm will sound and the UPS will switch to Bypass Mode where utility power is powering directly to the connected loads.

However, Battery Mode won't occur available when the UPS:

- Is overheating.
- Has an overload condition of 101 to 110% for more than 120 seconds.
- Has an overload condition of 111 to 150% for more than 20 seconds.
- Has an overload condition greater than 150%.
- Detects a fault in the battery or UPS electronics.

In Bypass Mode, solid lines will be lit from the Input Power symbol to the Load symbol and from the Input Power symbol to the Charger and Battery symbols. The Low-speed Fan symbol will also be lit.

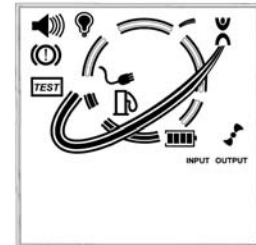

▶ **GREEN MODE**

When the UPS has Green Mode enabled, it will switch to Bypass Mode when the connected load is less than 3% of the UPS rating. The graphic LCD display will show Bypass Mode with the Green Mode symbol flashing. If the load is over 3% of the UPS rating, then the UPS will operate in Normal Mode with the Green Mode symbol lit. To enable or disable Green Mode, please refer to the Configuration Settings section of this manual or contact your service representative.

3. Operation

3.4 Configuration Settings

Press the FUNCTION/TEST button and SET/ALARM SILENCE button at same time for one second. Alarm will sound one beep; the unit is in Configuration Mode.

There are eight Bit columns at the bottom of the graphic LCD display. From left to right, they are identified as Bit 7 to Bit 0. When the UPS is in Configuration Mode, Bit 0 will be lit. Press the FUNCTION/TEST button to move between Bit 0 to Bit 6. When changing from Bit 0 to Bit 6, check to see if Bit 7 is lit. If it is, then that located Bit is set. Pressing the SET/ALARM SILENCE button will toggle between set and unset.

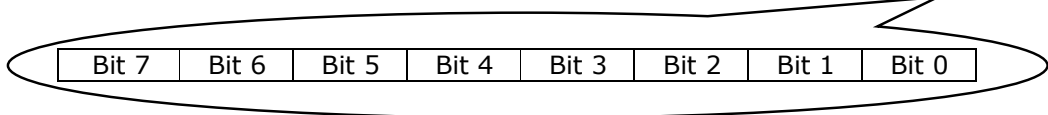
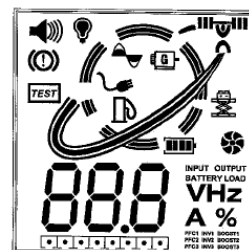

Bit Definition Table

Key Button	Setting	Bit Definition					
SET/Alarm Button	Status Setting	Bit 7	On=lit Off=unlit				
Function Button	Green Mode	Bit 3	On: Disable Green Mode Off: Enable Green Mode				
	UPS INVERTER OUTPUT VOLTAGE	Output Voltage	208V (100V)	220V (110V)	230V (115V)	240V (120V)	
		Bit 1	Off	Off	On	On	
		Bit 0	Off	On	Off	On	

► Green Mode

Enable/Disable Green Mode

1. Pressing the *FUNCTION/TEST* and *SET/ALARM SILENCE* buttons at the same time for 1 second. Alarm will sound one beep; the UPS is in configuration mode .
2. Press the *FUNCTION/TEST* button until Bit 3 is lit. If Bit 7 is lit, then Green Mode is disabled. If Bit 7 is unlit, then Green Mode is enabled.
3. To change the setting, press the *SET/ALARM SILENCE* button once.
4. After changing to the desired setting, press the *FUNCTION/TEST* and *SET/ALARM SILENCE* buttons at same time for one second. An audible beep will sound and the Green Mode setting is set.

3. Operation

▶ Output Voltage



NEVER change the voltage settings when the UPS is ON and powering connected loads.

1. Press FUNCTION/TEST and SET/ALARM SILENCE buttons at the same time for one second. A short beep will signal that UPS is ready for configuration settings.
2. Press the Function/Test button until Bit0 or Bit 1 is lit. If the Bit0 and Bit1 are lit, then output voltage is 240V for FP1000/ FP1600/ FP2500/ FP3200 or Output voltage is 120V for FP1000/FP1600/FP2200/FP3000.
3. To change the setting, press the SET/ALARM SILENCE button once.

Example: Change output voltage form 100V to 120V

1. Press the FUNCTION/TEST button until Bit 0 is lit.

Bit 7	Bit 6	Bit 5	Bit 4	Bit 3	Bit 2	Bit 1	Bit 0
							●

2. Press the SET/ALARM SILENCE button so that Bit 7 is lit.

Bit 7	Bit 6	Bit 5	Bit 4	Bit 3	Bit 2	Bit 1	Bit 0
●							●

3. Press the FUNCTION/TEST button so that Bit 1 is lit.

Bit 7	Bit 6	Bit 5	Bit 4	Bit 3	Bit 2	Bit 1	Bit 0
						●	

4. Press the SET/ALARM SILENCE button so that Bit 7 is unlit.

Bit 7	Bit 6	Bit 5	Bit 4	Bit 3	Bit 2	Bit 1	Bit 0
●						●	

5. Press the FUNCTION/TEST and SET/ALARM SILENCE buttons at the same time for one second. A short beep will signal that the UPS has returned to normal display.

6. Restart the UPS.



1. New settings for Green Mode will take effect immediately. For all other settings, please restart the UPS due to safe reason.
2. Setting the output voltage to 100 VAC will de-rate the VA and Watt ratings listed in the specifications of the UPS.

3. Operation

3.5 Cruiser Software

► Introduction

The Cruiser software has been designed with user-friendly operating status & icons to be easier acknowledge and operation. Cruiser can send warning messages to a pager, via e-mail or over a LAN. thus providing an early warning system for power failures, system shutdown and a variety of other scenarios. It allows a faster response time, even when the user is not locally available.

Features

- Green Mode support
- PFC status display
- Cross platform support
- UPS monitoring utility
- Scheduled system shutdown
- Graphic display of UPS status
- Warning notification via e-mail or pager
- Customized controls
- User-definable warnings
- Multi-language versions
- "Read & Write" functions when setting output voltage and frequency (optional)

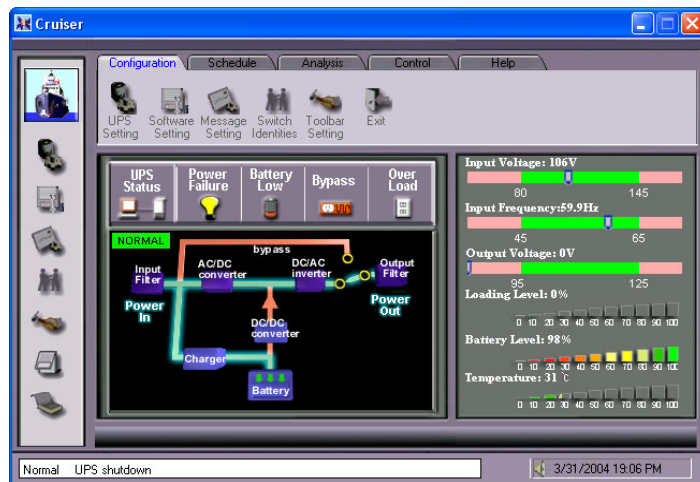

System Requirements

- IBM compatible computer
- Windows 95/NT4.0/98SE/ME/2000/XP and 2003
- Linux Red Hat 7.0~7.3, 8.0 and 9.0
- Linux Mandrake 8.2 and 9.0
- 32MB RAM
- 20MB available hard-drive space
- TCP/IP protocol
- Internet connection
- RS232 serial port or USB port
- CD-ROM drive (for installation)

Interface & OS Compatibilities

RS232

Windows: Win95, WinNT4.0, Win98SE, Win2000, WinMe, WinXP
 Linux: 7.0~7.3, 8.0~8.4, 9.0
 Mandrake: 8.2, 2.3, 8.4, 9.0
 Novell: 4.x, 5.1

USB

Windows: Win98SE, Win2000, WinMe, WinXP

3. Operation

▶ Installation

1. Insert the Cruiser CD into the CD-ROM Drive.
2. The setup program will automatically run. If it does not, then simply double-click on the **setup.exe** file on the CD. (Note1)
3. Follow all the on-screen instructions.

Step 1: Click Next to continue.

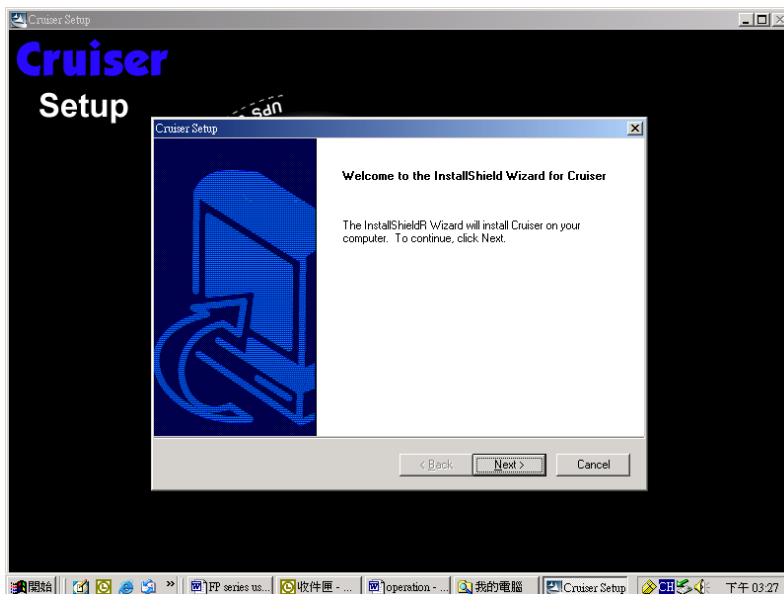

3. Operation

Step 2: Type in User Name and Company Name.

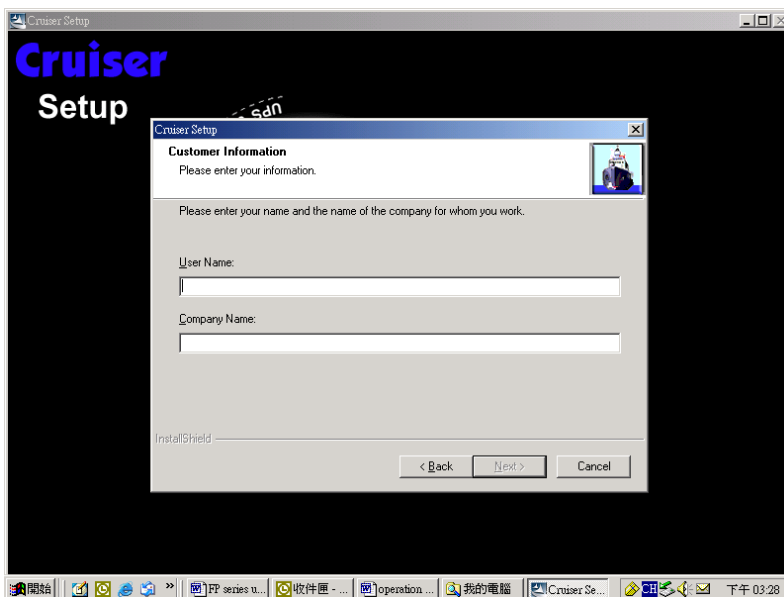

Step 3: Type in the Serial Number.

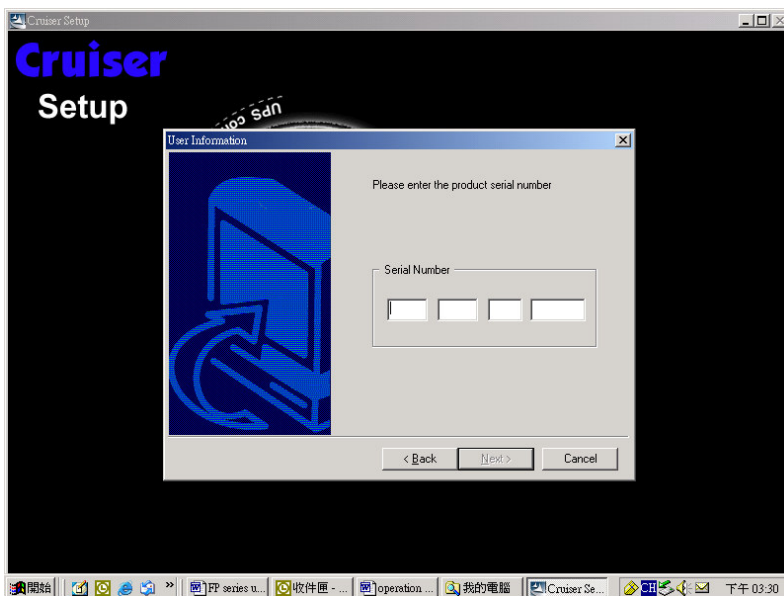

3. Operation

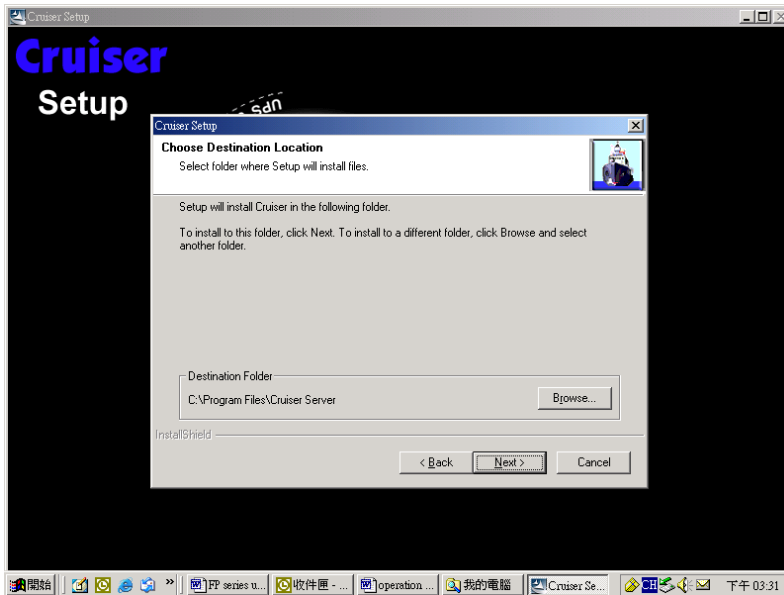

Step 4: Choose the Destination Folder

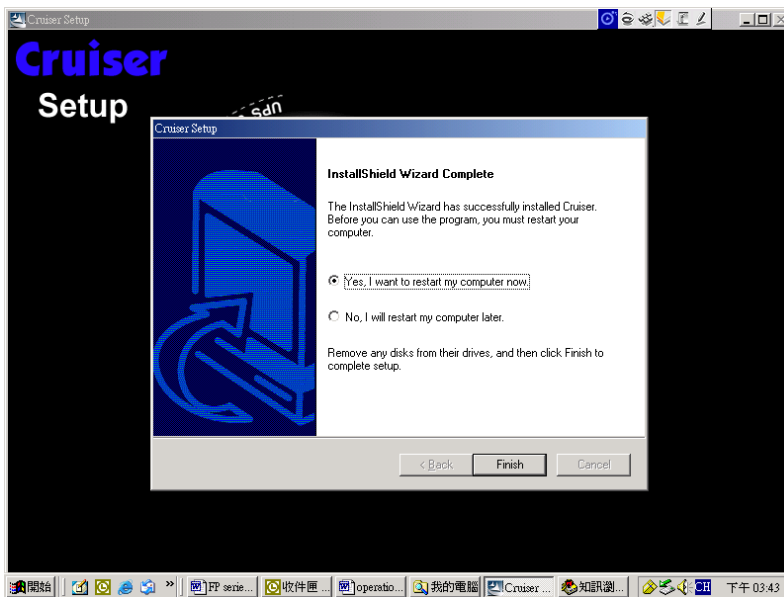

Step 5: Restart the computer.



3. Operation

Step6: After finishing the installation, the setup process will create the Cruiser program group in Programs Files and add its icon  to System task bar. **Right click** on Cruiser icon  will pop up its program menu.

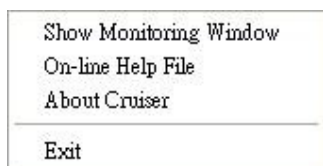
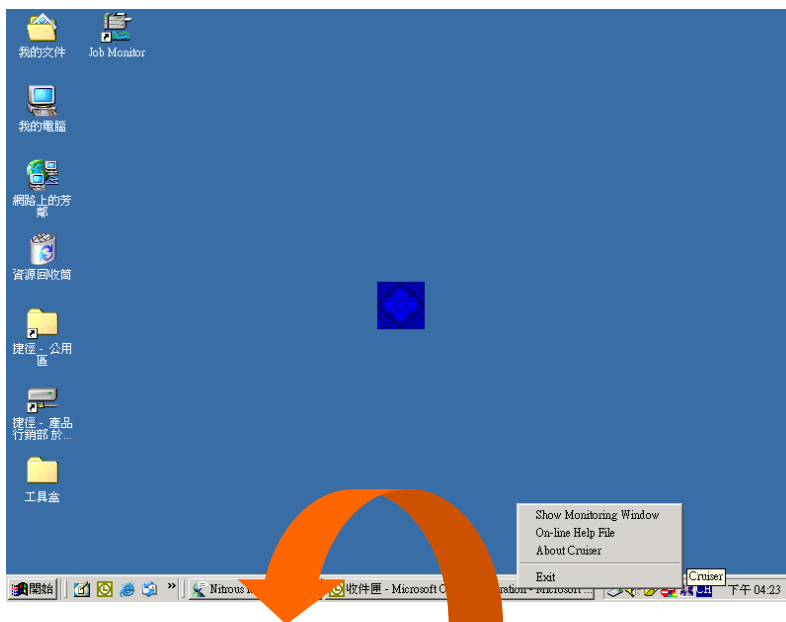

- **Hide/Show Monitoring Window:**
- This function is to hide/show the Cruiser's monitoring window.
- **On-line Help File:**
- This option is to launch the on-line help file which will help you to use Cruiser well.
- **About Cruiser:**
- This option is to show the information about Cruiser.
- **Exit:**
- This option is to close Cruiser and remove it from your computer memory.



- **When the UPS communication with PC via RS232, the optional slot can't be installed any card.**
- **Close others software concerning using the COM1 port if it is running on Quick Start.**

4. Maintenance

4.1 General Maintenance

The FP-Series UPS requires very little maintenance. The batteries are sealed, valve-regulated, maintenance-free and enclosed in a fire-retardant pack. The batteries should be kept charged to maintain their designed lifetime. When utility power is supplied to the UPS, it will continuously charge the batteries.

▶ **Environment**

- For the best preventive maintenance, keep the area around the UPS clean and dust-free.
- Please keep unobstructed air in the exhaust holes of UPS.
- Operate the UPS in an indoor environment with an ambient temperature range of 32°F to +104°F (0°C to +40°C).
- Keep the UPS on a flat, stable surface with adequate space around it for proper ventilation.
- Do not place the unit near a heat source and avoid placing the unit in direct sunlight.
- Do not place the unit near water or excessive moisture.

▶ **Storing the UPS and battery**

When storing the UPS for any length of time, it is recommended to plug in the UPS for at least 24 hours every four to six months to ensure full battery recharge.

▶ **When to replace the battery**

It is suggested that the battery pack be replaced every two years to ensure that the UPS provides full backup capacity during a blackout. Batteries should be checked every two to three months by pressing the FUNCTION/TEST button to conduct a test in Normal Mode. If the UPS produces a long beep and switches back to Normal Mode within ten seconds, then the batteries may need replacing. Contact your service representative to order a new battery pack or battery module.

4. Maintenance

4.2 Battery Pack Replacement

With the hot-swappable battery pack design, the FP-Series UPS batteries can be easily replaced without turning off the UPS or disconnecting the load. The batteries can also be replaced by shutting down the UPS first. This is done by pressing the ON/OFF button for one second and letting the UPS switch to Bypass Mode; then turn off the Input Breaker switch and unplug the UPS.

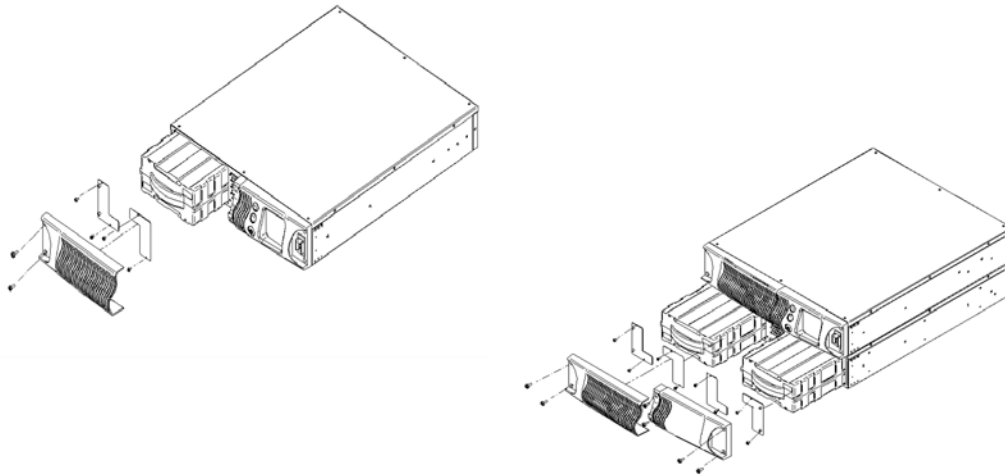

1. Loosen and remove the screws on the left side of the front panel. Remove the panel from the unit.
2. Loosen and remove the screws of battery stoppers.
3. Hold the battery pack and pull it out of the front of the unit.
4. Line up and slide in the new replacement battery pack.
5. Gently push the battery pack until a tight connection is made with the unit.
6. Re-install the battery stoppers with the screws.
7. Re-install the panel to the unit with the screws.



Do not disconnect the batteries while the UPS is in battery mode!

4. Maintenance

4.3 Testing new batteries

Start up the UPS with load added. Press the FUNCTION/TEST button for three seconds to activate the self-test. If the UPS switches back to Normal Mode after 10 seconds, then the batteries are good. If it does not, then please check the battery cable or connections. Contact your sales representative for assistance.

4.4 Recycling the used battery

Do not discard the UPS, the battery pack, or batteries into the trash. Contact your local recycling or hazardous waste center for information on proper disposal of used battery pack and batteries.



Consider all warnings, cautions, and notes before replacing batteries. Batteries can present a risk of electrical shock and high short circuit current. The following precautions should be observed when working on batteries:

- **Remove watches, rings, and other metal objects.**
- **Use tools with insulated handles.**
- **Do not lay tools or metal parts on top of batteries.**
- **Do not attempt to alter any battery wiring or connectors. Attempting to alter wiring can cause injury.**
- **Do not dispose of batteries in a fire. The batteries may explode. Refer to your local codes for disposal requirements.**
- **Do not open or mutilate the battery or batteries. Released electrolyte is harmful to the skin and eyes. It may be toxic.**

4.5 Fuse replacement

The output fuse is located at the rear of the UPS. Before changing the fuse, turn off the UPS and unplug the input cable from the AC source.

1. Press and rotate the fuse holder counter-clockwise.
2. Replace the fuse with one of similar type and rating. Re-install the assembly into the UPS. Press and rotate the fuse holder clockwise until it locks into position.
3. Reconnect the input power cord to the input AC source.
4. Restart the UPS.

5. Troubleshooting

5.1 Audible alarms and status

Audible Alarms	Possible Cause	Action
Three short beeps	1. Utility voltage error.	1. UPS is in Battery Mode, check the input voltage.
Four short beeps	1. Utility frequency error.	1. UPS is in Battery Mode, remove the input power and check the input frequency.
Five short beeps	1. UPS internal overheating. 2. Fan failure.	1. Check the ventilation and remove any object blocking air passage. 2. Call for service to replace the fan.
Six short beeps	1. PFC over-current.	1. Input AC voltage may be too low. Disconnect some load to remove the alarm.
Seven short beeps followed by three long beeps	1. Battery backup time running down.	1. Save any important data and turn off the computer. Wait for utility power to return.
Long continuous beep	1. Output overload. 2. Charger failure. 3. UPS fault.	1. Disconnect some load. 2. Call for service. 3. Call for service.



If the above actions do not resolve your problem, then please contact your sales representative.

5. Troubleshooting

5.2 Troubleshooting Guide

Problem	Possible Cause	Action
UPS will not turn on	<ol style="list-style-type: none"> 1. Input breaker switch is OFF. 2. UPS input breaker has tripped. 3. Input/battery cables not connected properly. 	<ol style="list-style-type: none"> 1. Ensure that the UPS Input breaker is switched ON. 2. Ensure the connected load is less than the UPS rating. 3. Ensure that input cable and battery cables are securely fitted into the UPS and battery module. Check that the battery breaker is switched ON.
UPS will not provide power to load	<ol style="list-style-type: none"> 1. Power only present on one output receptacle. 2. No output from output receptacles. 3. Output fails as soon as load connected. 	<ol style="list-style-type: none"> 1. Check the output fuse. 2. Check the connected cable. 3. Load exceeds maximum UPS rating. Remove some load.
UPS operates from battery despite presence of utility power	<ol style="list-style-type: none"> 1. Input fuse blown. 2. Generator does not power the UPS. 	<ol style="list-style-type: none"> 1. Replace input fuse. 2. Check that the generator is properly governed for both frequency and voltage. Some low-grade generators will not supply power stable enough to run a UPS.
UPS drops the load and switches to Bypass Mode	Load exceeds UPS rating.	<ol style="list-style-type: none"> 1. Disconnect some load from UPS.
UPS battery time is not long enough or the unit does not run on battery at all	<ol style="list-style-type: none"> 1. Batteries may need replacing. 	<ol style="list-style-type: none"> 1. Press Function/Test button. If UPS switches to Normal Mode within ten seconds, then change the batteries.
UPS is beeping	<ol style="list-style-type: none"> 1. Refer to audible alarms table. 	<ol style="list-style-type: none"> 1. Refer to the audible alarms table.
UPS in Bypass Mode after disabling Green Mode.	<ol style="list-style-type: none"> 1. UPS has not started in Normal Mode. 	<ol style="list-style-type: none"> 1. Press STANDBY button. Alarm will beep once and UPS switches to Normal Mode.
Button on front panel does not work	<ol style="list-style-type: none"> 1. UPS in start-up mode. 2. Button damaged. 	<ol style="list-style-type: none"> 1. Wait for start-up to complete. 2. Call service for a Returned Material Authorization (RMA) number.

6. Appendix

6.1 Technical characteristics

▶ Design principle

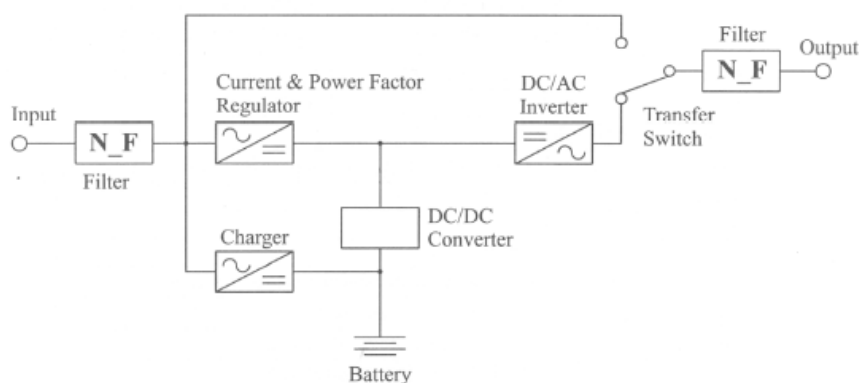

▶ Components description

→ **Input filter**

This printed board assembly provides surge protection, certified by IEC 61000-4-5 and IEC 801-5, and filters both electro-magnetic interference (EMI) and radio frequency interference (RFI). It minimizes surges and interference present in the utility line and keeps sensitive equipment protected.

→ **Current and power factor regulator**

In normal operation, this circuit converts utility AC power to regulated DC power for the inverter to use. This ensures that the input current has a sinewave form so that current distortion will not reflect back to the utility. The FP-Series UPS can tolerate a wide input range and has an overload power factor regulator alarm to alert the user that the UPS has a heavy output load in abnormal low input voltage to extend the reliability of the unit.

→ **DC/AC inverter**

In normal operation, the inverter utilizes the regulated DC output and inverts it into precise, regulated sinewave AC power. When the utility power fails, the inverter will receive its required energy from the battery through the DC/DC converter. In both modes of operation, the UPS inverter is on-line and continuously generates clean, precise, regulated AC power for load. Current is very stable even with nonlinear loads.

6. Appendix

→ **Charger**

The battery charger uses the energy from the utility power and precisely regulates it to continuously charge the batteries by "constant power" mode. The batteries are charged whenever the FP-Series UPS is plugged into utility power. The charger will operate as long as the input voltage is over 60 VAC.

→ **DC/DC converter**

The DC/DC converter utilizes energy from the batteries and boosts up the DC voltage to the operating voltage for inverter. This allows the inverter to operate continuously at optimum efficiency and voltage.

→ **Battery**

The FP-Series UPS utilizes a flame-retardant battery pack comprised of four 12V 7AH, valve-regulated, and sealed lead acid batteries. All FP battery packs are interchangeable and are easy to install or change. To maintain battery life, the UPS should operate in an ambient temperature of 68°F to 77°F (20°C to 25°C). Battery modules containing two battery packs are available for extended battery run times.

→ **Transfer switch**

The FP-Series UPS provides an alternate path to energize the connected load. If the UPS has an overload, over input current, over crest-factor load (designed for 3:1 nonlinear loads), failure condition, or is overheating, then it will automatically switch so that power is being supplied by the utility power. When this occurs, an audible alarm will sound and a visual indication will be shown on the LCD display.

→ **Output filter**

This filter prevents electro-magnetic conductance (EMC) leakage and RFI noise to output. It minimizes interference present in the inverter and utility line to keep sensitive equipment protect.

6. Appendix

6.2 Specifications

► General specifications

The principal operating characteristics of the FP-Series UPS at 25°C ambient operating temperature is shown below.

MODEL	FP1000	FP1600	FP2500	FP3200
INPUT				
Input Voltage (Nominal input voltage)	230 V (160 ~ 276 V)			
Nominal input Frequency	50 / 60 Hz \pm 5 Hz			
Input PFC	>0.98 @ full load			
OUTPUT				
Power	1000VA/700W	1600VA/1120W	2500VA/1750W	3200VA/2240W
Output Voltage (Output Voltage Regulation)	208V / 220V / 230V / 240V (Rated Voltage \pm 2%)			
Output Frequency	50/60HZ (Auto-tracking)			
High Efficiency Mode (AC to AC)	>86%	>86%	>88%	>88%
Output T.H.D	< 3% at linear load			
Overload Capacity	Sustaining 50sec @ 108% load; 28sec @ 110~120% load; 15sec @ 120~130% load; 9sec @ 140~145% load; Immediate Response @ 150%			
Crest ratio	3:1			
Transfer Time	Zero for power failures or recoveries. < 4msec for UPS to Bypass or reverse.			
BATTERY				
Battery Packs	1×48VDC Battery Pack	1×48VDC Battery Pack	2×48VDC Battery Pack (96V)	2×48VDC Battery Pack (96V)
Typical Backup Time (Full/Half load)	8/25 minutes	7/18 minutes	8/20 minutes	6/17 minutes
Battery Type	Sealed VRLA 12V7AH; Hot-Swappable			
Recharge Time to 90%	8 hours			
Extended Battery Cabinet	Extended Battery Module in 2U high (comprises 2×48VDC Battery Packs)			
MECHANICAL				
Dimensions-Rackmount (W×H×D in mm)	426 × 88(2U) × 500mm	426 × 88(2U) × 500mm	426 × 176(4U) × 500mm	426 × 176(4U) × 500mm
Weight(UPS / Battery Packs)	12/11.2 kgs	12/11.2 kgs	13.2/31.2 kgs	13.4/31.4 kgs
Total Weight	23.2 kgs	23.2 kgs	44.4 kgs	44.6 kgs
Conformance				
EMI/RFI Compatibility	EN50091-2 Class B, EN55022B	EN50091-2 Class B, EN55022B	EN50091-2 Class B, EN55022B	EN50091-2 Class B, EN55022B
Safety Certifications	CE , TUV / GS	CE , TUV / GS	CE , TUV / GS	CE , TUV / GS

6. Appendix

MODEL	FP1000	FP1500	FP2200	FP3000
INPUT				
Input Voltage (Nominal input voltage)	120 V (80 ~ 138 V)			
Nominal input Frequency	50 / 60 Hz ±5 Hz			
Input PFC	>0.98 @ full load			
OUTPUT				
Power	1000VA/700W	1500VA/1050W	2200VA/1540W	3000VA/2100W
Output Voltage (Output Voltage Regulation)	100V / 110V / 115V / 120V (Rated Voltage ± 2%)			
Output Frequency	50/60HZ (Auto-tracking)			
High Efficiency Mode (AC to AC)	>86%	>86%	>88%	>88%
Output T.H.D	<3% at linear load			
Overload Capacity	Sustaining 50sec @ 108% load; 28sec @ 110~120% load; 15sec @ 120~130% load; 9sec @ 140~145% load; Immediate Response @ 150%			
Crest ratio	3:1			
AC/AC Efficiency	>86%			
Transfer Time	Zero for power failures or recoveries. <4msec for UPS to Bypass or reverse.			
BATTERY				
Battery Packs	1×48VDC Battery Pack	1×48VDC Battery Pack	2×48VDC Battery Pack (96V)	2×48VDC Battery Pack (96V)
Typical Backup Time (Full/Half load)	8/25 minutes	7/18 minutes	8/20 minutes	6/17 minutes
Battery Type	Sealed VRLA 12V7AH; Hot-Swappable			
Recharge Time to 90%	8 hours			
Extended Battery Cabinet	Extended Battery Module in 2U high (comprises 2×48VDC Battery Packs)			
COMMUNICATIONS INTERFACE				
Communications port	RS-232 Port (Standard); DB9, AS400, USB Card (optional)			
SNMP Manageable	Yes			
MECHANICAL				
Dimensions-Rackmount (W×H×D in inches)	16.8 × 3.5(2U) × 19.7	16.8 × 3.5(2U) × 19.7	16.8 × 7(4U) × 19.7	16.8 × 7(4U) × 19.7
Weight(UPS/Battery Module)	26.4/24.7 lbs.	26.4/24.7 lbs.	29/67.8 lbs.	29.5/69.2 lbs.
Total Weight	51.1 lbs.	51.1 lbs.	97.8 lbs.	98.2 lbs.
Conformance				
EMI/RFI Compatibility	FCC Class B*	FCC Class B*	FCC Class B*	FCC Class B*
Safety Certifications	UL	UL	UL	UL

* This equipment has been tested and found to comply with the limits for a Class B digital device, pursuant to Part 15 of the FCC Rules. These limits are designed to provide reasonable protection against harmful interference when the equipment is operated in a commercial environment. This equipment generates, uses, and can radiate radio frequency energy and, if not installed and used in accordance with the instruction manual, may cause harmful interference to radio communications. Operation of this equipment in a residential area is likely to cause harmful interference in which case the user will be required to correct the interference at his own expense.

6. Appendix

MODELS: FP1000-FP3200	
CONTROL FRONT PANEL	
Buttons	STANDBY, FUNCTION and SET
Indications	Fault, Charger, PFC, Green, Line, Booster, Inverter, Bypass, Load at 25/50/75/100%, Batteries at 25/50/75/100%.
Audible Alarms	DC Mode, Low Battery, Voltage Error, Frequency Error, Charger Failure, Overheating, Overload, Fault, PFC Overload.
COMMUNICATIONS INTERFACE	
Communications port	RS-232 Port (Standard); DB9, AS400, USB Card (optional)
SNMP Manageable	Yes
ENVIRONMENT	
Operating Temperature	0°C~+40°C (32°F~104°F)
Storage Temperature	-15 ~ +50°C
Audible Noise (1 meter from surface of unit)	≤45dBA
Relative Humidity	0%~95% (non-condensing)

6. Appendix

▶ Battery Run Time

RUN TIME CHART in Minutes										
Output load	200 VA (140 W)	400 VA (280 W)	600 VA (420W)	800 VA (560W)	1000 VA (700 W)	1500 VA (1050 W)	2000 VA (1400 W)	2500 VA (1750 W)	3000 VA (2100 W)	3200 VA (2240 W)
UPS Model										
FP 1000	59	32	18	12	8					
+1 BM	260	134	83	58	50					
+1BM + 1BMc	466	247	166	124	91					
+2BM + 1BMc	-	358	250	183	146					
FP 1500	63	34	19	13	9	7				
+1 BM	274	142	88	62	53	31				
+1BM + 1BMc	491	260	175	131	96	60				
+2BM + 1BMc	-	377	264	193	154	92				
FP 1600	67	38	21	15	10	8				
+1 BM	279	148	93	64	55	33				
+1BM + 1BMc	505	266	179	135	98	62				
+2BM + 1BMc	-	380	268	196	157	94				
FP 2200	242	88	62	42	31	12	9			
+1 BMc	373	241	184	98	75	43	27			
+1BM + 1BMc	-	487	244	172	140	62	52			
+1BM + 2BMc	-	-	364	243	195	101	66			
FP 2500	247	92	65	47	34	15	9	8		
+1 BMc	379	244	186	107	78	44	29	20		
+1BM + 1BMc	-	491	249	179	142	66	53	41		
+1BM + 2BMc	-	-	366	255	197	104	68	58		
FP 3000	253	94	67	49	36	18	11	8	6	
+1 BMc	383	246	189	109	79	49	29	21	16	
+1BM + 1BMc	-	493	153	182	147	69	54	42	31	
+1BM + 2BMc	-	-	367	259	202	106	69	59	49	
FP 3200	255	95	69	50	36	19	12	9	7	6
+1 BMc	385	247	190	111	81	50	30	21	17	16
+1BM + 1BMc	-	495	156	183	148	70	55	43	32	30
+1BM + 2BMc	-	-	369	261	204	107	70	60	50	48



Indicates time not calculated, contact sales representative for details.

6. Appendix

6.3 Contact information

Asia

Allis Electric Co., Ltd.

12th F1., No.19-11, San-Chung Road, Nan Kang District,
Taipei 115, Taiwan R.O.C.

Tel:886-2-2655-3456 Fax:886-2-2655-2286~7

E-mail: sales@allis.com.tw <http://www.allis.com.tw>

Sheen Asia Electronics Co., Ltd.

2F, Building A2, Beiwei Industrial Area, GETDD, Guangzhou,
People's Republic of China, 510730

Tel:+86-20-8222 1370/1 Fax:+86-20-8222-1419

E-mail: sales@sheenasia.com <http://www.sheenasia.com>

North America

IMP Enterprises, inc.

18218 East McDermott, Suite E, Irvine, California 92614, U.S.A

Tel:+1-949-477-9198 Fax:+1-949-477-9195

E-mail: sales@impenterprises.com <http://www.impenterprises.com>

Europe

AEC SpA

Via Vesuvio 1 I-20054 NOVA MILANESE MI, Italy

Tel:+39-0362364535 Fax:+39-02-700-427499

+39 0362366059

E-mail: sales@aeceuro.com <http://www.aeceuro.com>